

Model No: D27TG35-06  
 Product Line: Tymphany

Rev: 2  
 Last Update: 2015-08-25 19:31:28

## Product Description

This D family tweeter features an 6 ohm 25 mm voice coil, a treated silk dome, large rear chamber for low resonant frequency, and a ferrofluid-cooled ferrite magnet motor. The large motor and rear chamber allow for robust power handling capacity. The tweeter comes with a faceplate with recessed mounting holes, for easy installation into the desired application.

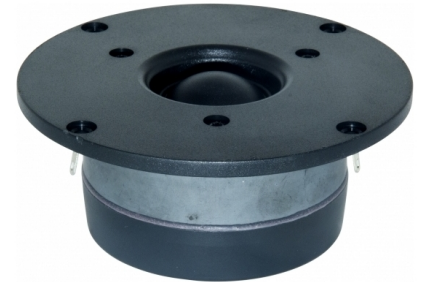

## Mechanical Drawing

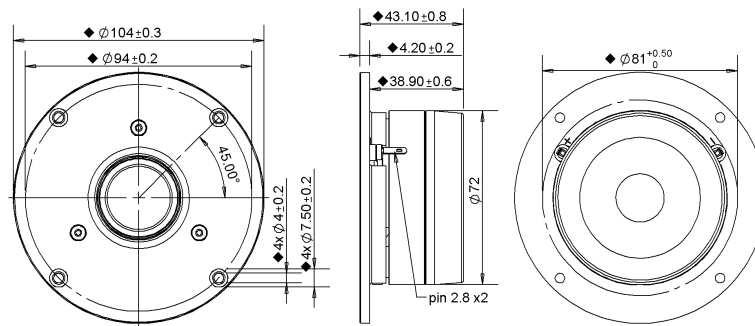

## Specifications

DC Resistance	Revc	Ohms	4.89	5.0%	Energy Bandwidth Product	EBP	(1/Qes)*fs
Minimum Impedance	Zmin	Ohms	5.49	7.5%	Moving Mass	Mms	g
Voice Coil Inductance	Le	mH	0.04		Suspension Compliance	Cms	um/N
Resonant Frequency	Fs	Hz	911.7	15%	Effective Cone diameter	D	cm
Mechanical Q Factor	Qms		1.21		Effective Piston Area	Sd	cm <sup>2</sup>
Electrical Q Factor	Qes		1.01		Effective Volume	Vas	L
Total Q Factor	Qts		0.55		Motor Force Factor	BL	Tm
Ratio Fs/Qts	F	Fs/Qts	1657.64		Motor Efficiency Factor	$\beta$	(T*M <sup>2</sup> )/Ohms
Half Space Sensitivity @2.83V	db@2.83V/1M	dB	92.77	+/- 1.0db	Voice coil former Material	VCfm	ASV
Half Space Sensitivity @1W/1M	db@1W/1M	dB	91.1	+/- 1.0db	Voice coil inner diameter	VCd	mm
Gap Height	Gh	mm	2.5		Rated Noise Power	P	W
Maximum Linear Excursion	Xmax	mm	0.5		Test Spectrum Bandwidth		2.5KHz - 20kHz
Ferrofluid Type	FF		APGL11		Driver Size	Inch	25 mm
Driver Mass	Kg		0.52				

## Frequency and Impedance Response

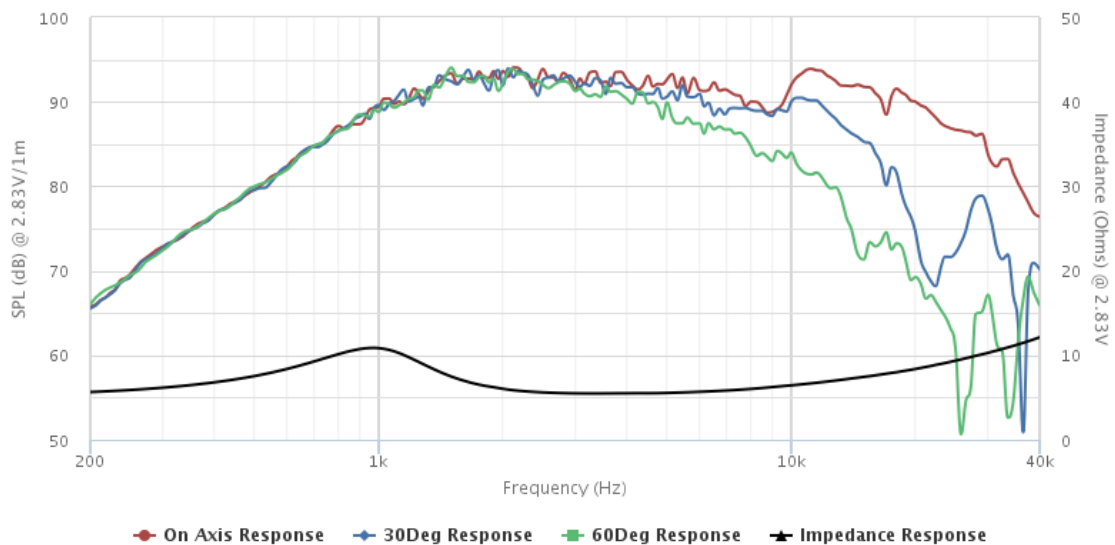

Highcharts.com