

Model No: DX20BF00-08
 Product Line: Tymphany

Rev: 3
 Last Update: 2016-05-31 20:50:01

Product Description

This DX family tweeter features a 19 mm 8 ohm voice coil, a damped silk diaphragm with large surround roll to produce a low resonant frequency, and a ferrite magnet motor which adds heat sinking for power handling capacity. The faceplate features recessed mounting holes to minimize reflections.



Mechanical Drawing

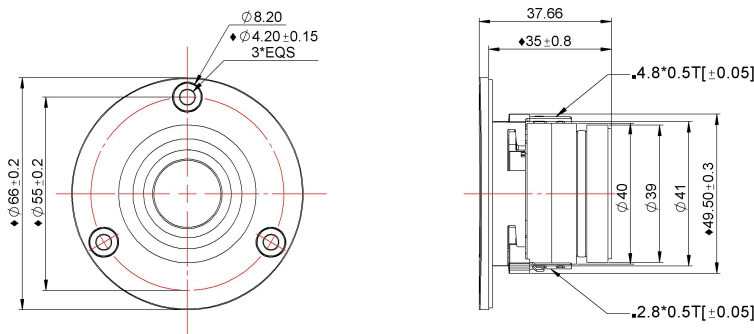

Specifications

DC Resistance	Revc	Ohms	7.52	5.0%	Energy Bandwidth Product	EBP	(1/Qes)*fs
Minimum Impedance	Zmin	Ohms	8.27	7.5%	Moving Mass	Mms	g
Voice Coil Inductance	Le	mH	0.02		Suspension Compliance	Cms	um/N
Resonant Frequency	Fs	Hz	810	15%	Effective Cone diameter	D	cm
Mechanical Q Factor	Qms		2.86		Effective Piston Area	Sd	cm ²
Electrical Q Factor	Qes		4.23		Effective Volume	Vas	L
Total Q Factor	Qts		1.71		Motor Force Factor	BL	Tm
Ratio Fs/Qts	F	Fs/Qts	474.24		Motor Efficiency Factor	β	(T*M ²)/Ohms
Half Space Sensitivity @2.83V	db@2.83V/1M	dB	86.12	+/- 1.0db	Voice coil former Material	VCfm	mm
Half Space Sensitivity @1W/1M	db@1W/1M	dB	86.3	+/- 1.0db	Voice coil inner diameter	VCd	mm
Gap Height	Gh	mm	2		Rated Noise Power	P	W
Maximum Linear Excursion	Xmax	mm	0.1		Test Spectrum Bandwidth		2.5KHz-20KHz
Ferrofluid Type	FF		APG O27N		Driver Size	Inch	20 mm
Driver Mass	Kg		0.17				

Frequency and Impedance Response

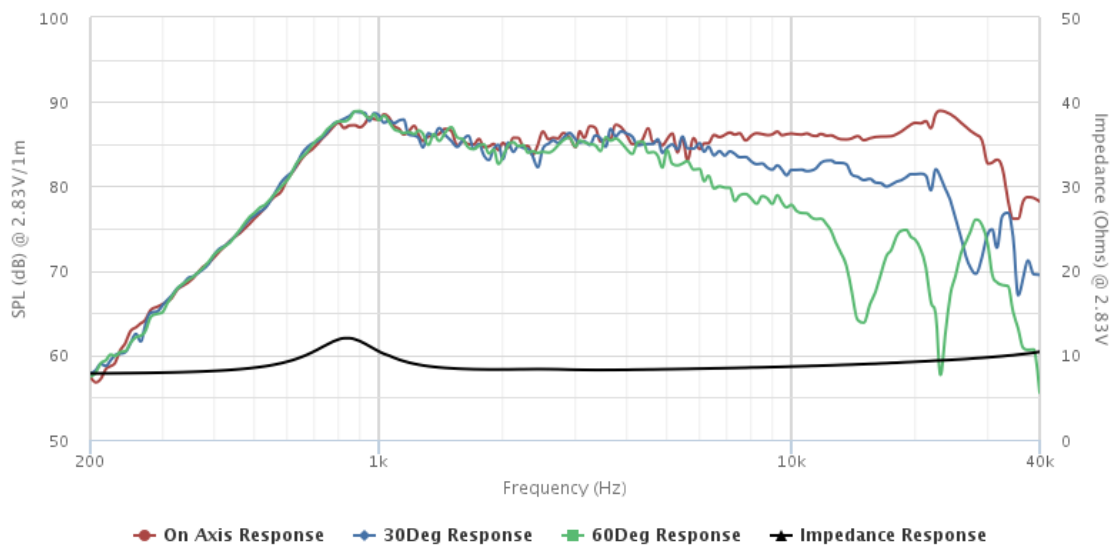

Highcharts.com