

Fostex®

FULL RANGE SPEAKER UNIT

FE208EΣ

Features

- HP (Hyperbolic Paraboloid) shell diaphragm
- 'ES cone' paper made of banana plant's fiber
- UDR tangential edge / damper
- ø 156mm large ferrite magnet



Specifications

&

Thiele/Small Parameters

Size	:	200 mm / 8 in
Voice Coil Diameter	:	35 mm / 1.3 in
Cast / Stamped	:	Cast
Impedance	:	8 Ω
Reproduction Frequency Response	:	fs - 14 kHz
Sound Pressure Level	:	97 dB/W(m)
Rated Input	:	40 W
Music Power	:	120W
Magnet Material	:	Ferrite
Magnet Weight	:	
(main)	:	1,408.7 g / 3.106 lb
(cancel)	:	n/a g / n/a lb
Net Weight	:	4,800 g / 10.58 lb

Frequency Response / Impedance

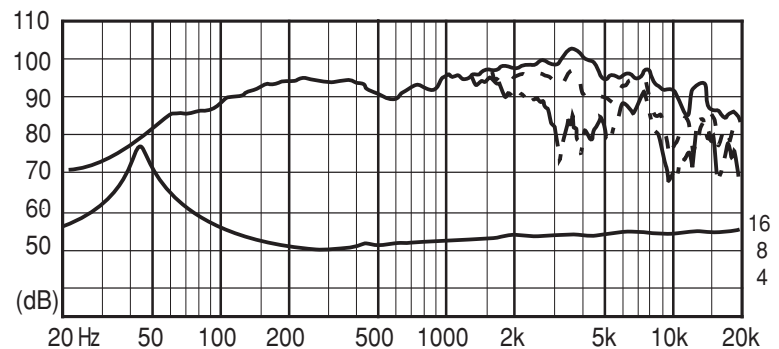

Dimensions & Mounting Information

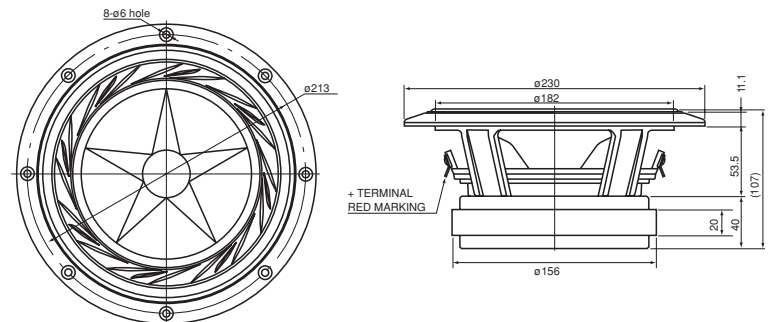

a :	80 mm
D :	144 mm
Sd :	0.0201 m ²
Zn :	8 Ω
Fs :	42 Hz
Re :	6.4 Ω
Le :	0.0517 mH
Qms :	6.191
Qes :	0.19
Qts :	0.18
Mms :	13.3 g
BL :	10.8 Telsa/m
Vas :	60.1 L
Xmax :	1.25 mm
Eff/η0 :	2.278 %
Cms :	1.069 mm/N
EBP :	221.05

Overall Diameter	:	230 mm / 9 in
Baffle Hole Diameter	:	182 mm / 7 in
Depth	:	93.5 mm / 4 in