

REVELATOR

WOOFER

26W/8867T00

The Revelator woofers and subwoofers features very rigid cones in paper or aluminium that operates as a piston over a wide frequency range, in combination with Scan-Speaks low-loss linear suspension and the patented Symmetrical Drive (SD-1) it results in very low distortion and a smooth and well behaved frequency response as well as perfect transient reproduction.

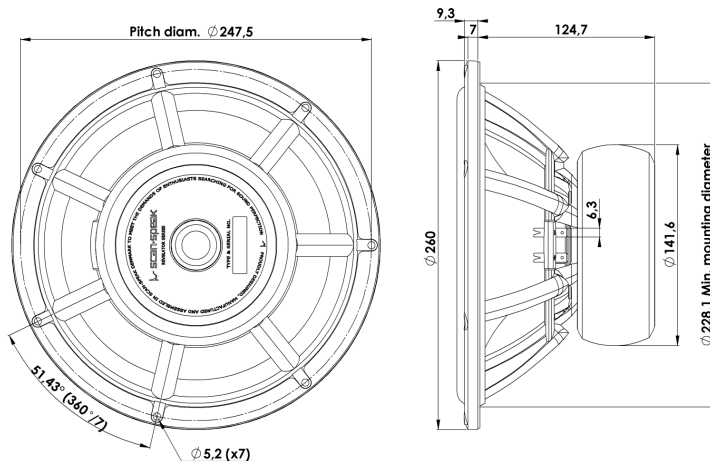

KEY FEATURES:

- Patented Symmetrical Drive Motor Design
- Low-Loss linear suspension
- Die cast Alu Chassis vented below spider
- Rigid Black Anodized Alu Cone
- Low Damping SBR Rubber Surround
- Ferrite Magnet System w. Rubber Boot

T-S Parameters

Resonance frequency [fs]	19 Hz
Mechanical Q factor [Qms]	4.50
Electrical Q factor [Qes]	0.31
Total Q factor [Qts]	0.29
Force factor [Bl]	11.2 Tm
Mechanical resistance [Rms]	1.51 kg/s
Moving mass [Mms]	57 g
Suspension compliance [Cms]	1.23 mm/N
Effective diaph. diameter [D]	202 mm
Effective piston area [Sd]	320 cm ²
Equivalent volume [Vas]	176 l
Sensitivity (2.83V/1m)	87 dB
Ratio Bl/√Re	4.65 N/√W
Ratio fs/Qts	66 Hz

Notes:

IEC specs. refer to IEC 60268-5 third edition.
All Scan-Speak products are RoHS compliant.
Data are subject to change without notice.
Datasheet updated: February 22, 2011.

Electrical Data

Nominal impedance [Zn]	8 Ω
Minimum impedance [Zmin]	6.8 Ω
Maximum impedance [Zo]	90.0 Ω
DC resistance [Re]	5.8 Ω
Voice coil inductance [Le]	0.4 mH

Power Handling

100h RMS noise test (IEC 17.1)	170 W
Long-term max power (IEC 17.3)	- W

Voice Coil and Magnet Data

Voice coil diameter	50 mm
Voice coil height	24 mm
Voice coil layers	2
Height of gap	6 mm
Linear excursion	± 9 mm
Max mech. excursion	± 14 mm
Unit weight	3.7 kg





REVELATOR

WOOFER

26W/8867T00

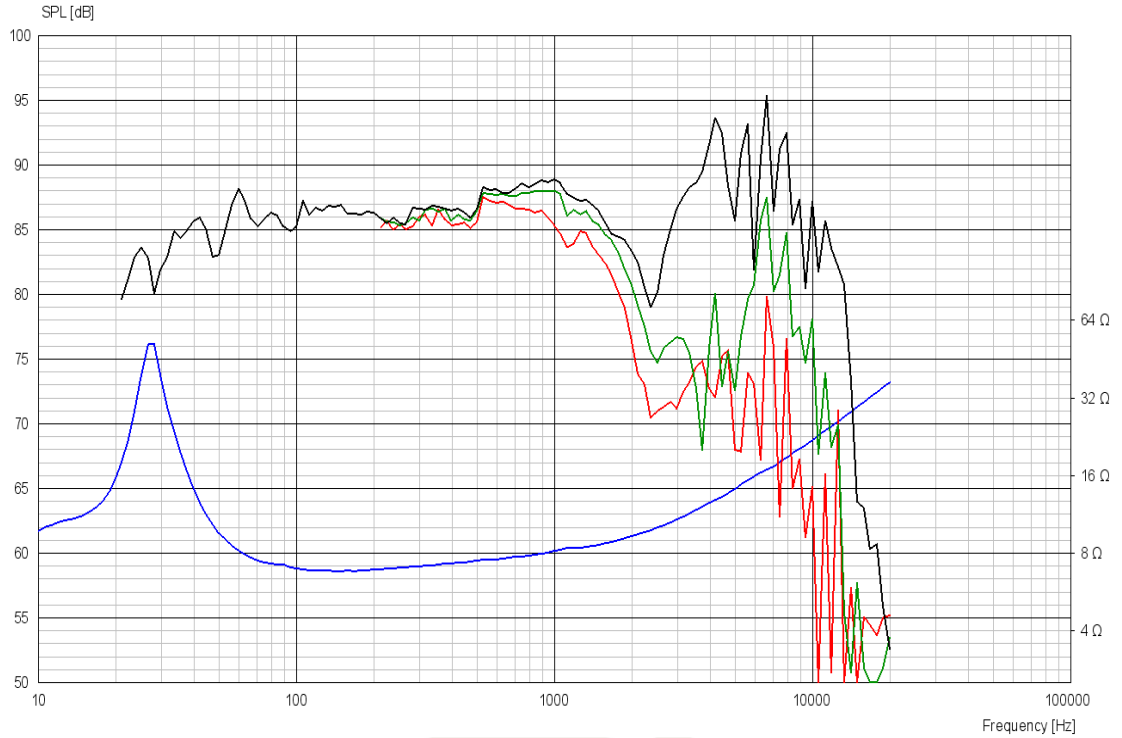

Advanced Parameters (Preliminary)



Electrical data:

Resistance [Re']	6.32 Ω
Free inductance [L _b]	0.170 mH
Bound inductance [L _e]	0.823 mH
Semi-inductance [K _e]	0.0379 SH
Shunt resistance [R _{ss}]	2309 Ω

Mechanical Data

Force Factor [Bl]	9.28 Tm
Moving mass [M _{ms}]	54.3 g
Compliance [C _{ms}]	1.12 mm/N
Mechanical resistance [R _{ms}]	0.086 kg/s
Admittance [A _{ms}]	0.210 mm/N

