

High quality compression driver with dome diaphragm in pure titanium, offers high efficiency and low distortion over the medium and high frequencies band.

It can be successfully used in studio monitors, stage boxes and sound reinforcement in small rooms, where a high performance is requested.

This performance results from the proper combination of the components.

Diaphragm type dome in pure, rigid, light and extremely thin titanium (0.025 mm). To avoid stress and distortion, the suspension has a special design.

Injected phase plug in engineering plastic, optimized to eliminate undesirable phase cancellations.

Magnetic assembly that concentrates flux in the gap, optimized using FEA (Finite Element Analysis).

Voice coil manufactured in CCAW (Copper Clad Aluminium Wire), Kapton® former, assures great stability and thermal resistance.

The moving assembly has a perfect auto-centering characteristic that turns replacement in an easy task.



OBS.: In order to change the repair easily, ANY KIND OF CONNECTION THAT YOU WISH TO USE SHOULDNT WELDED AT D200 TERMINAL'S DRIVER. This will cause the loose of the product's warranty. Selenium engineers suggest to use the faston connectors supplied.

SPECIFICATIONS

Nominal impedance	8	Ω
Minimum impedance @ 5,743 Hz	6.8	Ω
Power handling		
Musical Program (w/ xover 1,500 Hz 12 dB / oct) ¹	120	W
Musical Program (w/ xover 2,000 Hz 12 dB / oct) ¹	160	W
Sensitivity		
On horn, 2.83V@1m, on axis ²	107	dB SPL
On plane-wave tube, 0.0894V ³	116	dB SPL
Frequency response @ -6 dB	1.000 to 22,000	Hz
Throat diameter	25 (1)	mm (in)
Diaphragm material	Titanium	
Voice coil diameter	44 (1.7)	mm (in)
Re	6.0	Ω
Flux density	1.60	T
Minimum recommended crossover (12 dB / oct)	1,500	Hz

¹ Power handling specifications refer to normal speech and/or music program material, reproduced by an amplifier producing no more than 5% distortion. Power is calculated as true RMS voltage squared divided by the nominal impedance of the loudspeaker. This voltage is measured at the input of the recommended passive crossover when placed between the power amplifier and loudspeaker.
Musical Program = 2 x W RMS.

² Measured with HL14-25 horn, 1,200 - 15,000 Hz average.

³ The sensitivity represents the SPL in a 25 mm terminated tube, 800 - 2,000 Hz average.

ADDITIONAL INFORMATION

Magnet material	Barium ferrite
Magnet weight	675 (24) g (oz)
Magnet diameter x depth	115 x 15 (4.52 x 0.59) mm (in)
Magnetic assembly weight	1,680 (3.7) g (lb)
Housing material	Plastic
Housing finish	Black
Voice coil material	CCA W
Voice coil former material	Polyimide (Kapton®)
Voice coil winding length	2.6 (8.53) m (ft)
Voice coil winding depth	2.7 (0.11) mm (in)
Wire temperature coefficient of resistance (α25)	0.00435 1/°C
Volume displaced by driver	0.5 (0.018) l (ft ³)
Net weight	1,730 (3.81) g (lb)
Gross weight	1,810 (3.99) g (lb)
Carton dimensions (W x D x H)	28 x 28 x 15 (11.0 x 11.0 x 5.9) cm (in)

MOUNTING INFORMATION

Horn connection	Bolt onl
Connectors	Faston
Polarity	Positive voltage applied to the positive terminal (red) gives diaphragm motion toward the throat

DRIVER x HORN CONNECTION

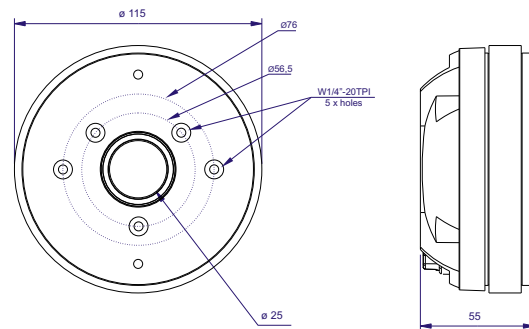
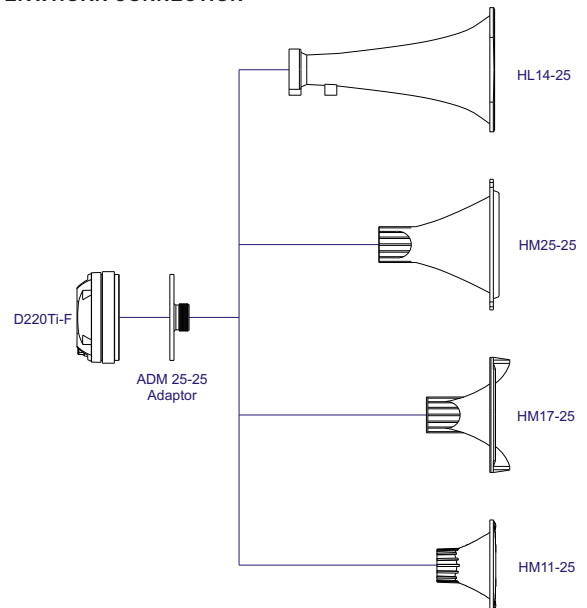

RESPONSE AND IMPEDANCE CURVES W/ HL14-25 HORN INSIDE AN ANECHOIC CHAMBER, 1 W / 1 m

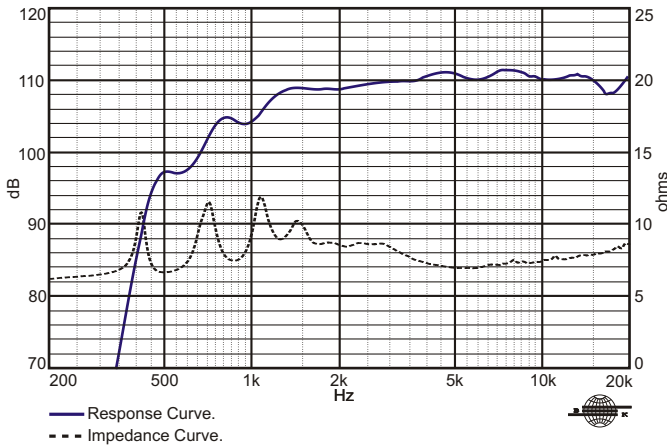

HARMONIC DISTORTION CURVES W/ HL14-25 HORN, 5 W / 1 m.

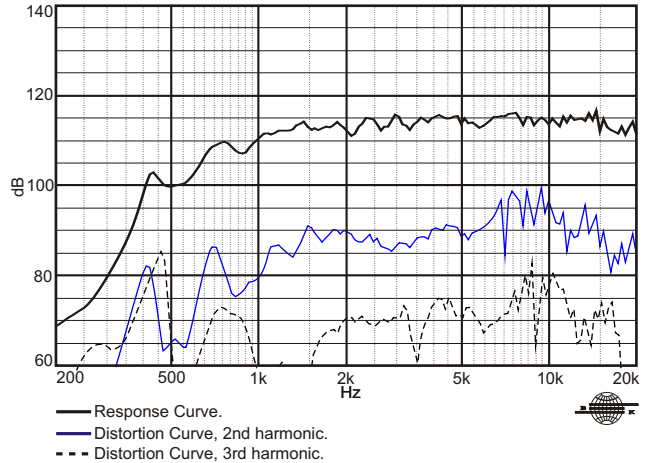

RESPONSE AND IMPEDANCE CURVES W/ PLANE-WAVE TUBE, 1 mW

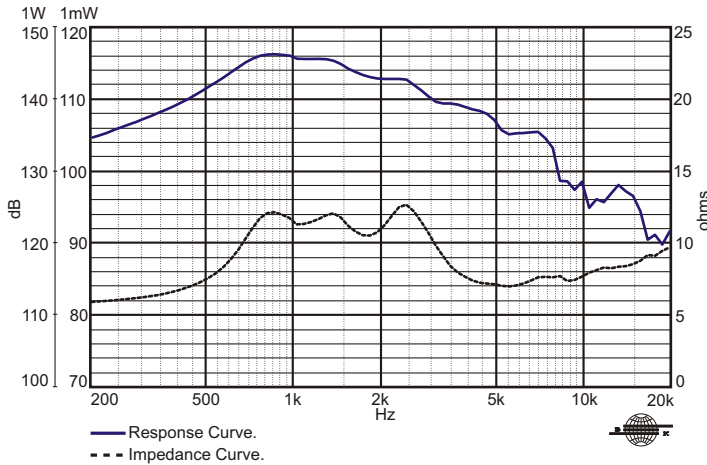

Frequency response and impedance curves measured with 25 mm terminated plane-wave tube.

POLAR RESPONSE CURVES

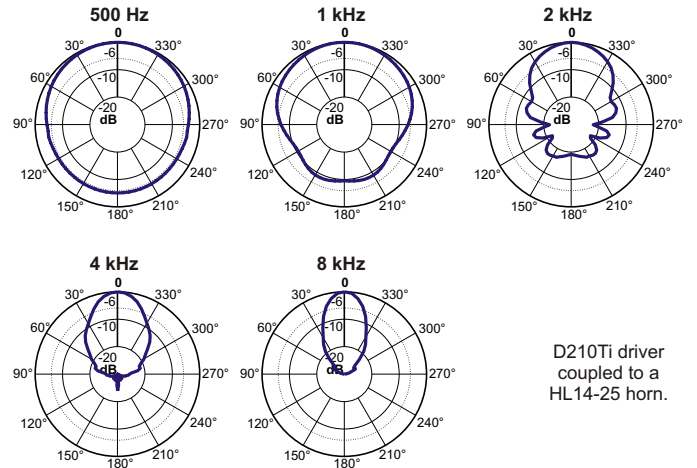

D210Ti driver coupled to a HL14-25 horn.

Polar Response Curve.

HARMONIC DISTORTION CURVES W/ HL14-25 HORN, 1 W / 1 m.

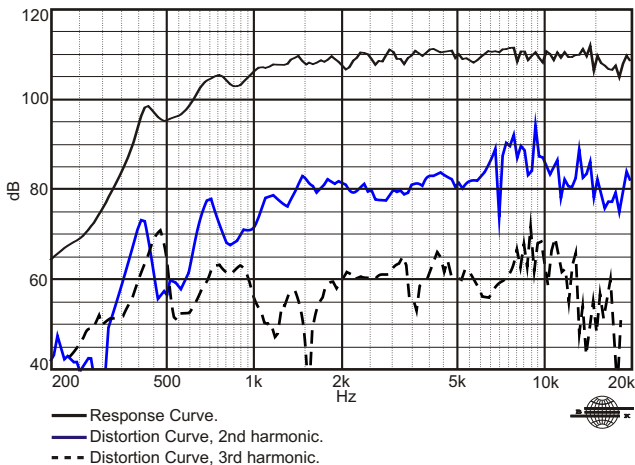

HOW TO CHOOSE THE RIGHT AMPLIFIER

The power amplifier must be able to supply twice the RMS driver power. This 3 dB headroom is necessary to handle the peaks that are common to musical programs. When the amplifier clips those peaks, high distortion arises and this may damage the transducer due to excessive heat. The use of compressors is a good practice to reduce music dynamics to safe levels.

FINDING VOICE COIL TEMPERATURE

It is very important to avoid maximum voice coil temperature. Since moving coil resistance (R_e) varies with temperature according to a well known law, we can calculate the temperature inside the voice coil by measuring the voice coil DC resistance:

$$T_B = T_A + \left(\frac{R_B}{R_A} - 1 \right) \left(T_A - 25 + \frac{1}{\alpha_{25}} \right)$$

T_A, T_B = voice coil temperatures in °C.

R_A, R_B = voice coil resistances at temperatures T_A and T_B , respectively.

α_{25} = voice coil wire temperature coefficient at 25 °C.

Kapton®: Du Pont trademark.

Ferrosound®: Ferrofluidics Corporation trademark.

Specifications subject to change without prior notice.

Cod.:N/A Rev.: 03- 10/06

www.selenium.com.br

www.seleniumloudspeakers.com