

The D3504Ti-Nd model is an ultra high quality compression driver for professional use wherever high SPL and low distortion are of great concern.

Pure titanium specially designed diaphragm with IPF® (Impregnated Polymer Fiber) surround, has structured type snow flake for high sensitivity, low distortion and smooth extended frequency response applications.

The D3504Ti-Nd is recommended for use in arenas, stage monitors, side fills and sound reinforcement systems.

Optimized aluminum injected phase plug avoids phase cancellation problems.

High flux density magnetic assembly with Neodymium ring and copper shorting ring that lowers distortion and reduces the voice coil self-inductance.

Protection circuit DPD® (Driver Protection Device). This circuit uses a PTC and a HPCR resistor assuring more reliability under overload condition.

Voice coil manufactured in CCAW (copper clad aluminum) uses a high temperature Polyimide former.

Precisely engineered diaphragm structure and alignment mechanism allow for easy, reliable and cost effective repair in case of diaphragm failure (RPD3300Ti).

In the rare case a repair may be necessary, please read carefully the instructions supplied and be sure to correctly follow the items step by step.

With a 1,4" exit throat and standard bolt pattern, it directly couples to Selenium horns with (36 mm) throats.

Cover in injected aluminum, assuring high mechanical resistance and a very shallow profile.

Driver D3504Ti-Nd must be used only with of 1,4 inches throat diameter.

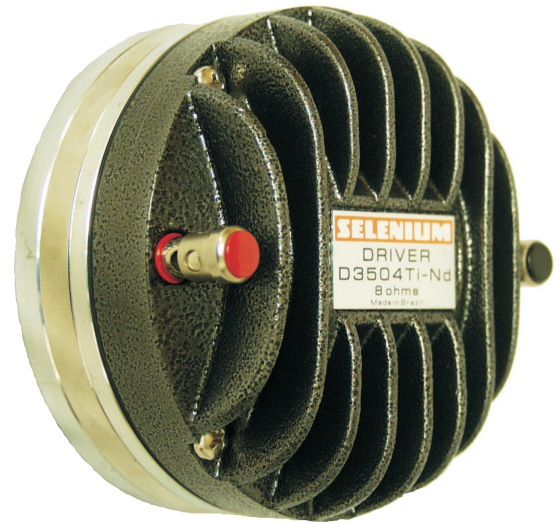

SPECIFICATIONS

Nominal impedance	8	Ω
Minimum impedance @ 4,926 Hz	6.1	Ω
Power handling		
Musical Program (w/ xover 800 Hz 12 dB / oct) ¹	150	W
Sensitivity		
On horn, 2.83V@1m, on axis ²	111	dB SPL
On plane-wave tube, 0.0894V ³	118	dB SPL
Frequency response @ -10 dB	500 to 20,000	Hz
Throat diameter	36 (1,4)	mm (in)
Diaphragm material	Titanium	
Voice coil diameter	75 (3)	mm (in)
Re	4.8	Ω
Flux density	2.0	T
Minimum recommended crossover (12 dB / oct)	800	Hz

¹ Power handling specifications refer to normal speech and/or music program material, reproduced by an amplifier producing no more than 5% distortion. Power is calculated as true RMS voltage squared divided by the nominal impedance of the loudspeaker. This voltage is measured at the input of the recommended passive crossover when placed between the power amplifier and loudspeaker.
Musical Program= 2 x W RMS.

² Measured with HL14-50 horn, 2,000 - 17,000 Hz average.

³ The sensitivity represents the SPL in a 25 mm terminated tube, 800 - 3,000 Hz average.

ADDITIONAL INFORMATION

Magnet material	Neodymium	
Magnet weight	610 (21,51)	g (oz)
Magnet diameter x depth	126 x 11 (4.96 x 0.43)	mm (in)
Magnetic assembly weight	2,400 (5.29)	g (lb)
Housing material	Aluminum	
Voice coil material	Flat CCAW	
Voice coil former material	Polyimide (Kapton®)	
Voice coil winding length	4.7 (15.4)	m (ft)
Voice coil winding depth	2.0 (0.08)	mm (in)
Wire temperature coefficient of resistance (α25)	0.00404	1/°C
Volume displaced by driver	1.0 (0.035)	l (ft ³)
Net weight	2,800 (6.17)	g (lb)
Gross weight	2,940 (6.48)	g (lb)
Carton dimensions (W x D x H)	15 x 15 x 10 (5.9 x 5.9 x 3.9)	cm (in)

MOUNTING INFORMATION

Horn connection	Bolt on
Number of holes	4 (M6) equally spaced threaded holes
Threaded holes diameter	102 (4) mm (in)
Connectors	Silver-plated push terminals
Polarity	Positive voltage applied to the positive terminal (red) gives diaphragm motion toward the throat

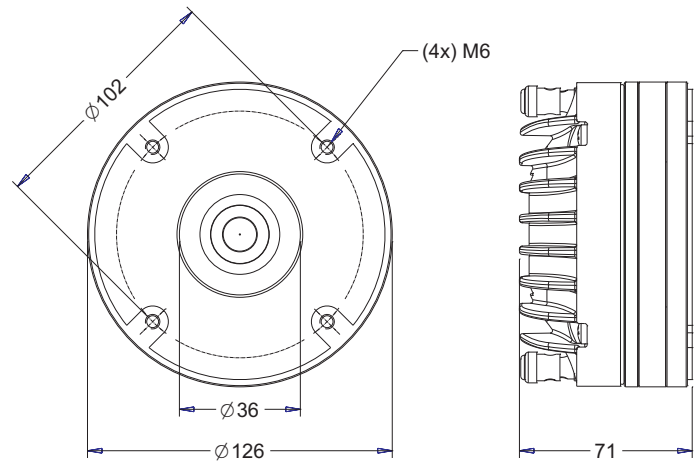

RESPONSE AND IMPEDANCE CURVES W/ HL14-50 HORN AND ADAPTER Ø1,4in x 1,96in (Ø36mmx50mm) INSIDE AN ANECHOIC CHAMBER, 1 W / 1 m

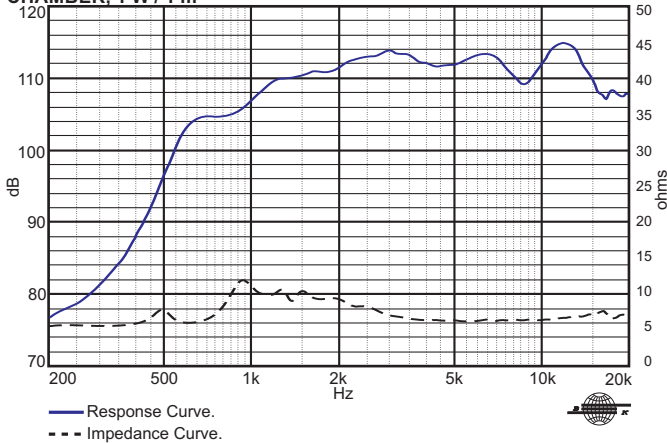

HARMONIC DISTORTION CURVES W/ HL14-50 HORN AND ADAPTER Ø1,4in x 1,96in (Ø36mmx50mm), 7.5 W / 1 m.

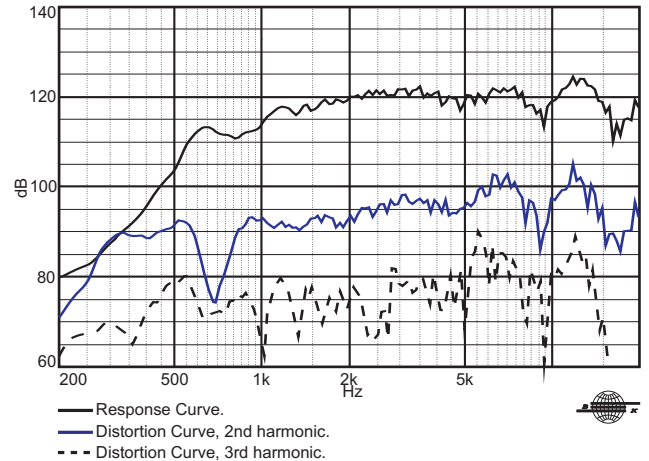

RESPONSE AND IMPEDANCE CURVES W/ PLANE-WAVE TUBE, 1 m W

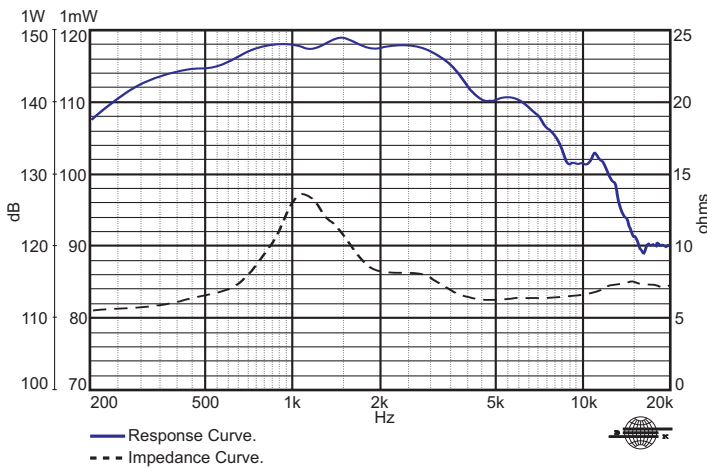

Frequency response and impedance curves measured with 25 mm terminated plane-wave tube.

POLAR RESPONSE CURVES

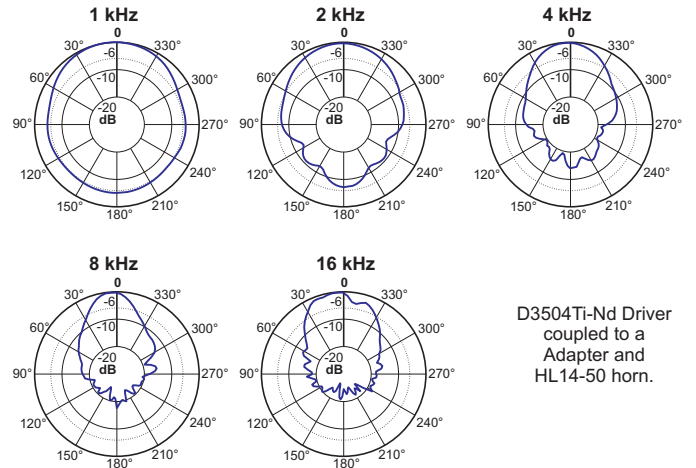

D3504Ti-Nd Driver coupled to a Adapter and HL14-50 horn.

— Polar Response Curve.

HARMONIC DISTORTION CURVES W/ HL14-50 HORN AND ADAPTER Ø1,4in x 1,96in (Ø36mmx50mm), 1 W / 1 m.

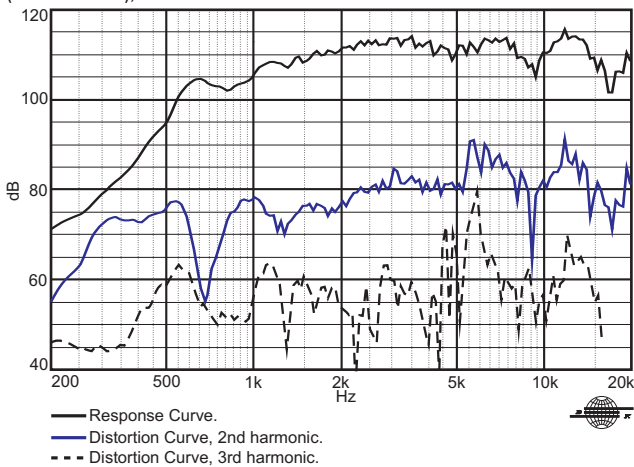

HOW TO CHOOSE THE RIGHT AMPLIFIER

The power amplifier must be able to supply twice the RMS driver power. This 3 dB headroom is necessary to handle the peaks that are common to musical programs. When the amplifier clips those peaks, high distortion arises and this may damage the transducer due to excessive heat. The use of compressors is a good practice to reduce music dynamics to safe levels.

FINDING VOICE COIL TEMPERATURE

It is very important to avoid maximum voice coil temperature. Since moving coil resistance (R_e) varies with temperature according to a well known law, we can calculate the temperature inside the voice coil by measuring the voice coil DC resistance:

$$T_B = T_A + \left(\frac{R_B}{R_A} - 1 \right) \left(T_A - 25 + \frac{1}{\alpha_{25}} \right)$$

T_A, T_B = voice coil temperatures in °C.

R_A, R_B = voice coil resistances at temperatures T_A and T_B , respectively.

α_{25} = voice coil wire temperature coefficient at 25 °C.

Kapton®: Du Pont trademark.

Ferrosound®: Ferrofluidics Corporation trademark.

Specifications subject to change without prior notice.

Cod.:N/A Rev.: 00- 08/07

www.selenium.com.br

www.seleniumloudspeakers.com