

2" (50 mm) exit compression driver for high sensitivity, low distortion and smooth extended frequency response applications. Its pure titanium diaphragm was especially designed based on the extremely light and structurally strong snowflake crystal. That leads the D408Ti driver to deliver high performance, high quality and high value for the pinnacle in sound reinforcement applications.

It combines a stable structure for mid-frequency reproduction and a low mass that enables high frequency reproduction virtually linear to 20 kHz.

Its construction features include.

Ferrofluid (Ferrosound®) loaded gap reducing heat build-up and offering consistent results over long-term demanding concert usage.

Voice coil is made of high temperature CCAW (copper clad aluminium wire) wound on Kapton® former to withstand high operating temperatures.

Injected plastic housing.

Precisely engineered diaphragm structure and alignment mechanism allows for easy, reliable and cost effective repair (model RPD4400Ti) in case of diaphragm failure.



SPECIFICATIONS

| | | |
|---|---------------|---------|
| Nominal impedance | 8 | |
| Minimum impedance @ 3,450 Hz | 6.3 | |
| Power handling | | |
| Musical Program(w/ xover 800 Hz 12 dB / oct) ¹ | 200 | W |
| Musical Program(w/ xover 1,200 Hz 12 dB / oct) ¹ | 250 | W |
| Sensitivity | | |
| On horn, 2.83V@1m, on axis ² | 111 | dB SPL |
| On plane-wave tube, 0.0894V ³ | 113 | dB SPL |
| Frequency response @ -10 dB | 400 to 20,000 | Hz |
| Throat diameter | 50 (2) | mm (in) |
| Diaphragm material | Titanium | |
| Voice coil diameter | 100 (4) | mm (in) |
| Re | 4.8 | |
| Flux density | 1.70 | T |
| Minimum recommended crossover (12 dB / oct) | 800 | Hz |

¹ Power handling specifications refer to normal speech and/or music program material, reproduced by an amplifier producing no more than 5% distortion. Power is calculated as true RMS voltage squared divided by the nominal impedance of the loudspeaker. This voltage is measured at the input of the recommended passive crossover when placed between the power amplifier and loudspeaker.
Musical Program= 2 x W RMS.

² Measured with HL4750-SLF horn, 800 - 6,000 Hz average.

³ The sensitivity represents the SPL in a 25 mm terminated tube, 400 - 3,000 Hz average.

ADDITIONAL INFORMATION

| | |
|--|--|
| Magnet material | Barium ferrite |
| Magnet weight | 2,640 (92) g (oz) |
| Magnet diameter x depth | 200 x 24 (7.87 x 0.95) mm (in) |
| Magnetic assembly weight | 7,860 (17.32) g (lb) |
| Housing material | Plastic |
| Housing finish | Gray |
| Voice coil material | CCAW |
| Voice coil former material | Polyimide (Kapton®) |
| Voice coil winding length | 6.0 (19.7) m (ft) |
| Voice coil winding depth | 2.0 (0.08) mm (in) |
| Wire temperature coefficient of resistance () | 0.00404 1/°C |
| Volume displaced by driver | 2.2 (0.078) l (ft ³) |
| Net weight | 8,540 (18.83) g (lb) |
| Gross weight | 8,720 (19.22) g (lb) |
| Carton dimensions (W x D x H) | 23 x 23 x 10 (9.1 x 9.1 x 3.9) cm (in) |

MOUNTING INFORMATION

| | |
|--------------------------------|--|
| Horn connection | Bolt on |
| Number of holes | 4 |
| Threaded holes circle diameter | 102 (4) mm (in) |
| Threaded holes diameter | M6 (0.23) mm (in) |
| Connectors | Push terminals |
| Polarity | Positive voltage applied to the positive terminal (red) gives diaphragm motion toward the throat |

DRIVER x HORN CONNECTION

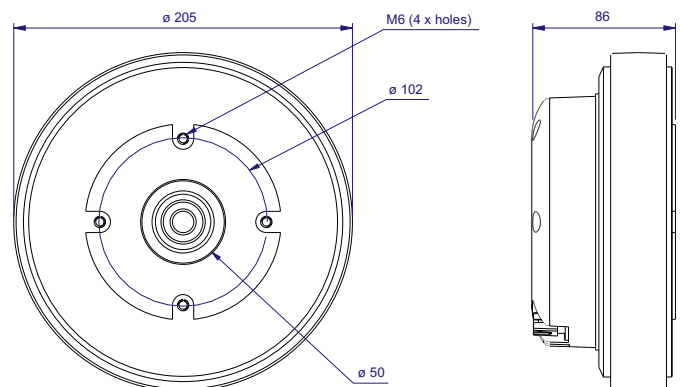
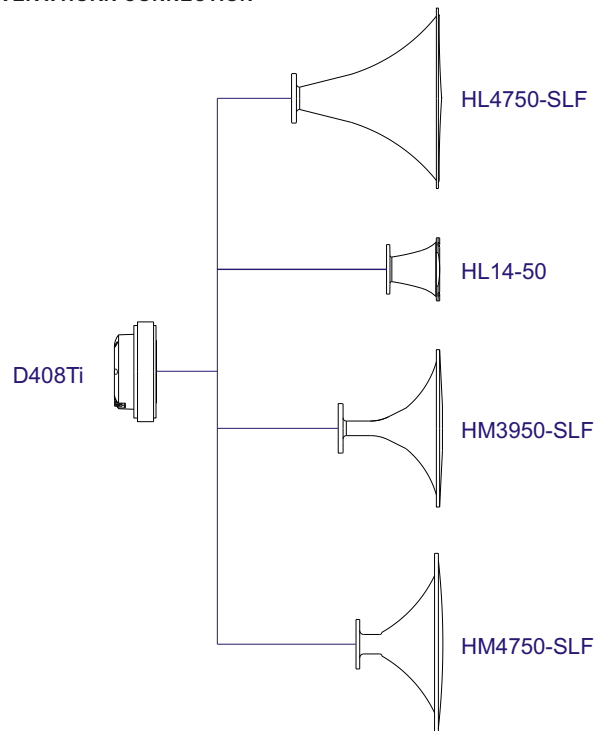

Dimensions in mm.

RESPONSE AND IMPEDANCE CURVES W/ HL4750-SLF HORN INSIDE AN ANECHOIC CHAMBER, 1W / 1 m

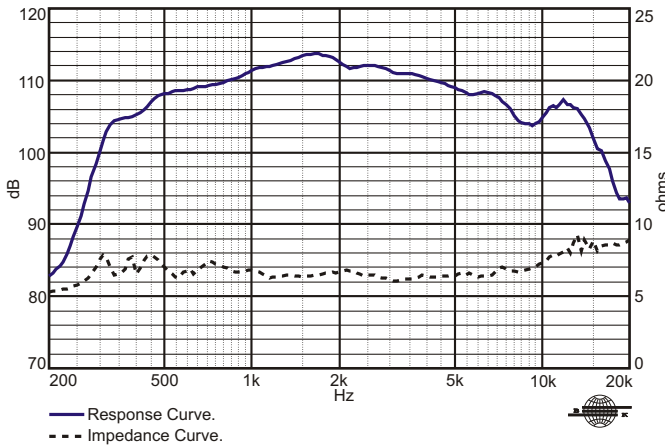

HARMONIC DISTORTION CURVES W/ HL4750-SLF HORN, 10 W / 1 m.

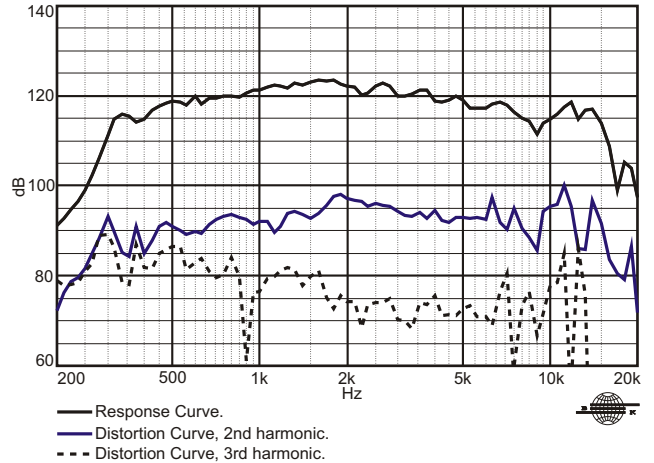

RESPONSE AND IMPEDANCE CURVES W/ PLANE-WAVE TUBE, 1 mW

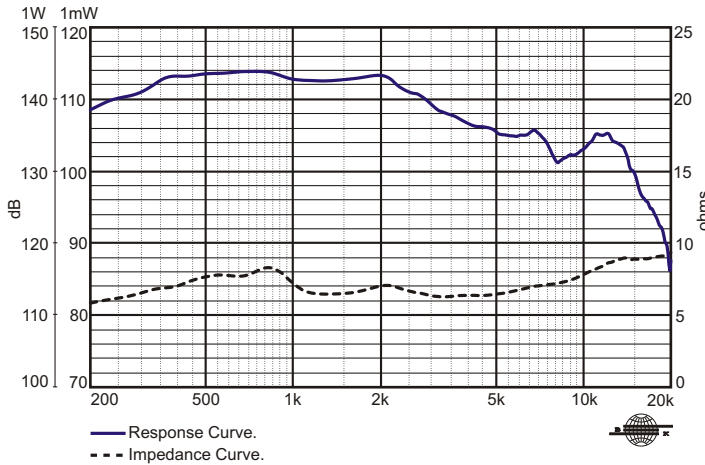

Frequency response and impedance curves measured with 50 mm terminated plane-wave tube, with sensitivity referenced to a 25 mm tube.

POLAR RESPONSE CURVES

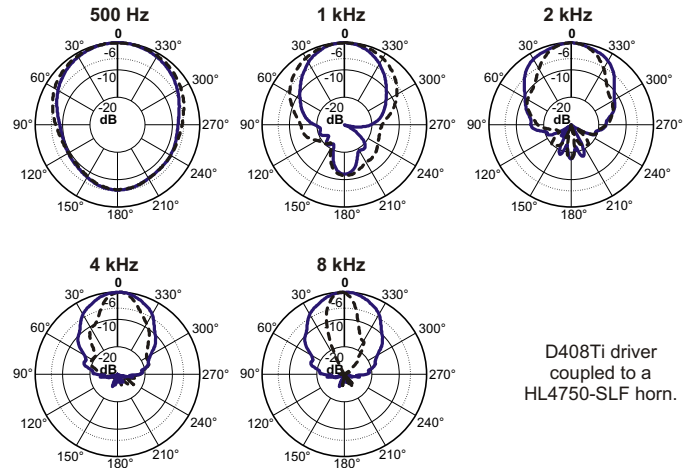

D408Ti driver coupled to a HL4750-SLF horn.

— Polar Response Curve, Horizontal.
- - - Polar Response Curve, Vertical.

HARMONIC DISTORTION CURVES W/ HL4750-SLF HORN, 1 W / 1 m.

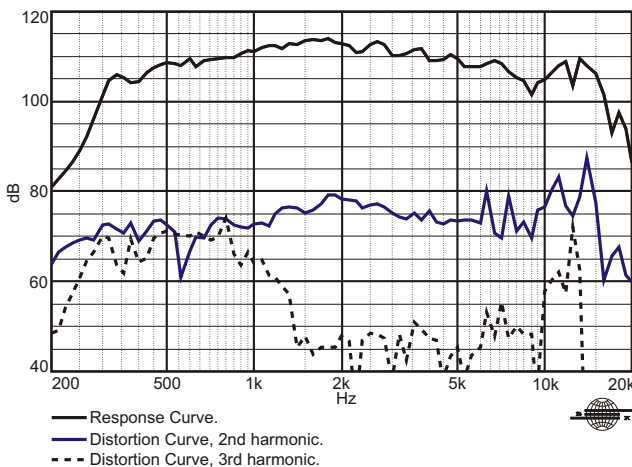

HOW TO CHOOSE THE RIGHT AMPLIFIER

The power amplifier must be able to supply twice the RMS driver power. This 3 dB headroom is necessary to handle the peaks that are common to musical programs. When the amplifier clips those peaks, high distortion arises and this may damage the transducer due to excessive heat. The use of compressors is a good practice to reduce music dynamics to safe levels.

FINDING VOICE COIL TEMPERATURE

It is very important to avoid maximum voice coil temperature. Since moving coil resistance (R_c) varies with temperature according to a well known law, we can calculate the temperature inside the voice coil by measuring the voice coil DC resistance:

$$T_B = T_A \frac{R_B}{R_A} - 1 T_A - 25 \frac{1}{25}$$

T_A, T_B = voice coil temperatures in °C.

R_A, R_B = voice coil resistances at temperatures T_A and T_B , respectively.

= voice coil wire temperature coefficient at 25 °C.

Kapton®: Du Pont trademark.

Ferrosound®: Ferrofluidics Corporation trademark.

Specifications subject to change without prior notice.

Cod.:152089 Rev.: 04- 01/06